



Application Alley

PARTNER | SOLVE | DELIVER

Electronics - Reed Sensor

Hands-Free Barcode Scanner Reed Sensor



Custom
Engineered
Solutions for
Tomorrow

Introduction

Most major food chains and retail stores process purchased items through their payment stations using electronic automatic barcode scanners. Most of these barcode scanners are equipped with a hands-free docking cradle. A Reed Sensor and magnet used in tandem, with the hand-held barcode scanner and docking cradle, allowing hands-free scanning mode, provide the most reliable results.

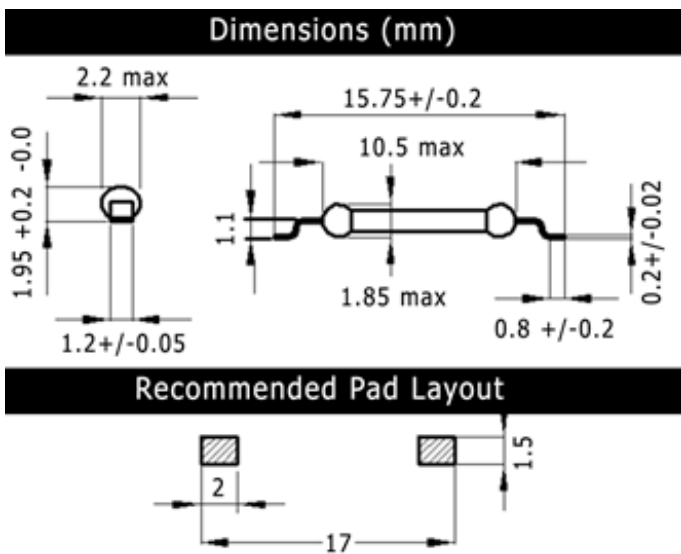

Figure 1. MK23 Sensor physical layout

Features

- Hermetically sealed
- Dynamically tested contacts
- Reliable switching
- Ability to activate and control the on and off points over large distances
- Millions of switching operations

Applications

- Sensing for barcode scanners in hands-free mode
- Sensing long distances when using devices requiring a docking cradle

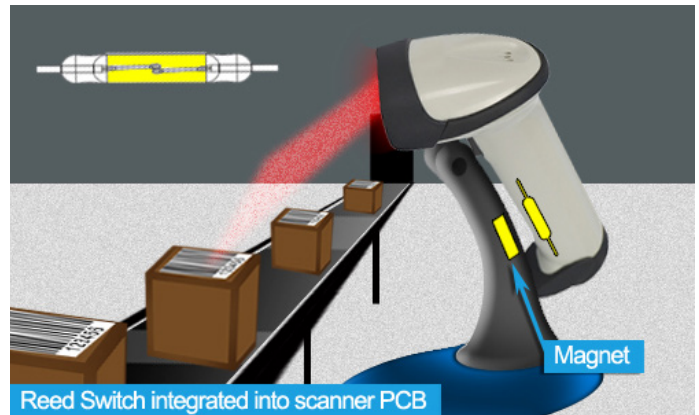

Figure 2. Hand-held barcode scanner and docking cradle in the hands-free mode.

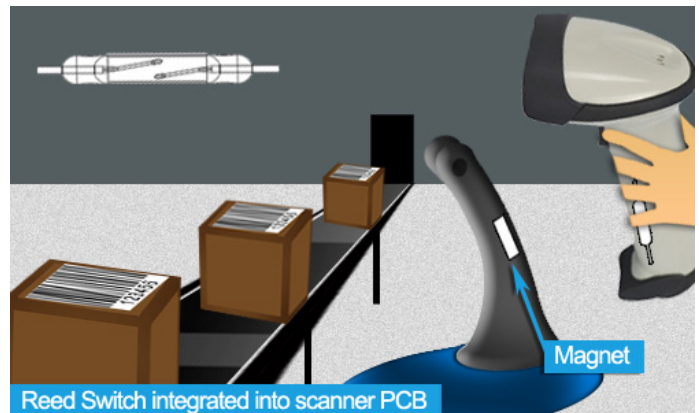

Figure 3. Barcode scanner is out of docking station, deactivating the Reed Sensor and switching off the hands-free mode.

Standex-Meder’s MK23-35 Reed Sensor Solves A Major Reliability Problem

Hand-held barcode scanners have become the norm in processing retail goods. They can automatically adjust inventory levels and improved operating costs. Many stores have even eliminated the sales clerk and allow customers to process their own purchases.

Because hand-held barcode scanners are portable, they can see high shock and vibration forces in their normal use, especially when dropped on hard surfaces.

Some mechanical switches and some Reed Switches are particularly sensitive to vibration and shock. So much so, that their actuate points can shift when dropped making them malfunction in the barcode scanner. Of course when this occurs there is inevitably a busy line of customers waiting for their purchases to be processed.

Standex-Meder's MK23-35 Reed Sensor is not susceptible to shock and vibrations forces. However, several of Standex-Meder's Reed Sensors were tested in authentic hand-held barcode scanners, in which they were dropped repeatedly from a height of 4 feet in all six axes, at various temperatures, with no failures and no significant changes to any of their specifications. Failures were reported in other types of sensors tested along side Standex-Meder's Reed Sensors. A full report is available upon request.

Specifications (@ 20°C) MK23 Series

	Min	Max	Units
Operate Specifications			
Must close distance	3.3	5.7	mm
Must open distance	4.3	12.3	mm
Hysteresis	Typical 50%		
Load characteristics			
Switching voltage		200	V
Switching current		1.0	Amps
Carry current		1.5	Amps
Contact rating		20	Watts
Static contact resistance		150	mΩ
Dynamic contact resistance	200		mΩ
Breakdown voltage	320		V
Operate time		0.5	msec
Release time		0.1	msec
Operate temp	-20	130	°C
Storage temp	-55	130	°C

Dimensions (mm)

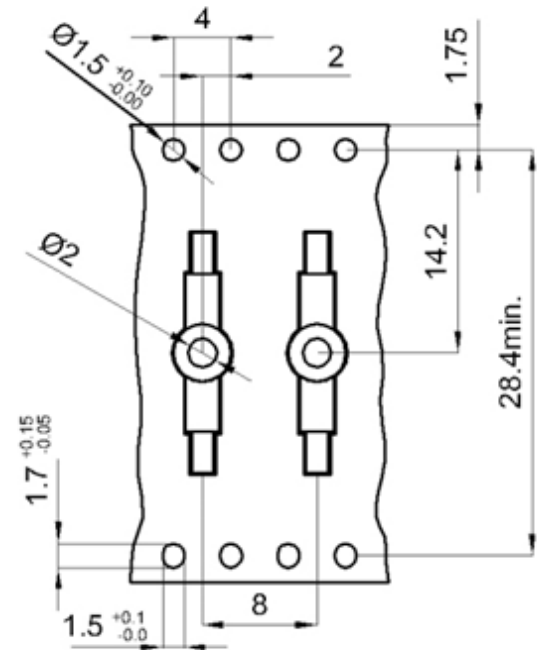









Figure 3. Hand-held barcode scanner dropped in 6 axes during shock testing.

Figure 4. MK23 Tape & Reel

Consider some of the below surface mount options for this application.

Surface Mount Sensor Series					
Series	Dimensions	mm		inches	Illustration
		mm	inches		
MK15	W	2.5	0.098		
	H	2.5	0.098		
	L	19.50	0.768		
MK16	W	2.3	0.091		
	H	2.3	0.091		
	L	15.60	0.614		
MK17	W	2.1	0.083		
	H	2.1	0.083		
	L	9.61	0.378		
MK22	W	2.7	1.060		
	H	2.3	0.091		
	L	15.60	0.614		
MK23-35	W	2.2	0.087		
	H	1.95	0.077		
	L	15.75	0.620		
MK23-66	W	2.2	0.087		
	H	2.7	1.060		
	L	19.60	0.772		
MK23-87	W	2.0	0.079		
	H	2.1	0.083		
	L	15.60	0.614		
MK23-90	W	2.54	0.100		
	H	3.05	0.120		
	L	24.9	0.980		

Find out more about our ability to propel your business with our products by visiting www.standexmeder.com or by giving us a hello@standexelectronics.com today! One of our engineers or solution selling sales leaders will listen to you immediately.

About Standex-Meder Electronics

Standex-Meder Electronics is a worldwide market leader in the design, development and manufacture of standard and custom electro-magnetic components, including magnetics products and reed switch-based solutions.

Our magnetic offerings include planar, Rogowski, current, and low- and high-frequency transformers and inductors. Our reed switch-based solutions include Meder, Standex and OKI brand reed switches, as well as a complete portfolio of reed relays, and a comprehensive array of fluid level, proximity, motion, water flow, HVAC condensate, hydraulic pressure differential, capacitive, conductive and inductive sensors.

We offer engineered product solutions for a broad spectrum of product applications in the automotive, medical, test and measurement, military and aerospace, as well as appliance and general industrial markets.

Standex-Meder Electronics has a commitment to absolute customer satisfaction and customer-driven innovation, with a global organization that offers sales support, engineering capabilities, and technical resources worldwide.

Headquartered in Cincinnati, Ohio, USA, Standex-Meder Electronics has eight manufacturing facilities in six countries, located in the United States, Germany, China, Mexico, the United Kingdom, and Canada.

For more information on Standex-Meder Electronics, please visit us on the web at www.standexmeder.com.

Contact Information:

Standex-Meder Electronics
World Headquarters
4538 Camberwell Road
Cincinnati, OH 45209 USA

Standex Americas (OH)
+1.866.STANDEX (+1.866.782.6339)
info@standexelectronics.com

Meder Americas (MA)
+1.800.870.5385
salesusa@standexmeder.com

Standex-Meder Asia (Shanghai)
+86.21.37820625
salesasia@standexmeder.com

Standex-Meder Europe (Germany)
+49.7731.8399.0
info@standexmeder.com